

Orion D 570F2/WC50EW Urban Lighting - Pole 4 Ways H.3000

Rev. 31/10/2023

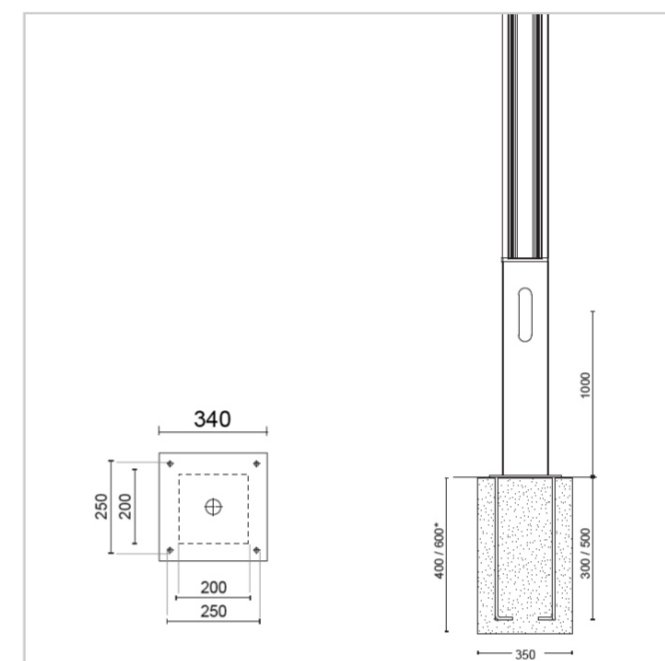

Column luminaire, for floor installation, with source light placed on top of fixture with a downward emission. This ensure an optimal light distribution on the ground and a better control of glaring effects. Floor fixing bracket with A2 steel clamps. Power supply with driver incorporated with fixed or dimmable output.

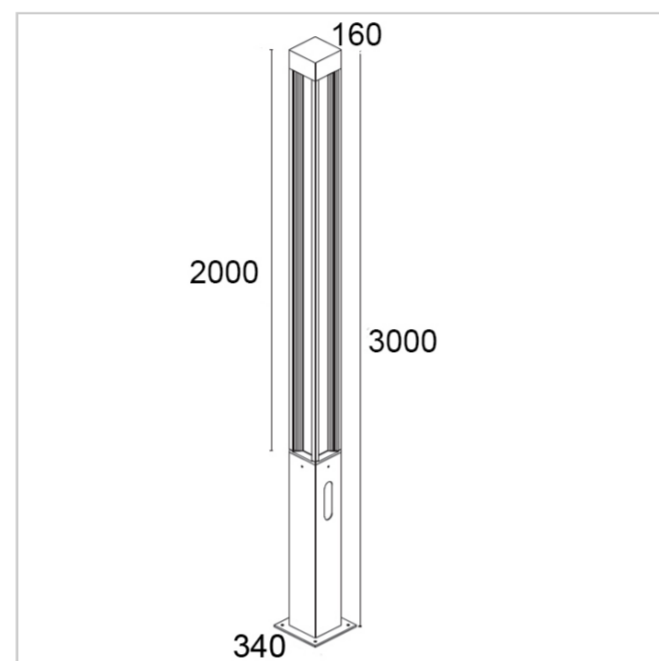

PHOTOMETRICAL DATA

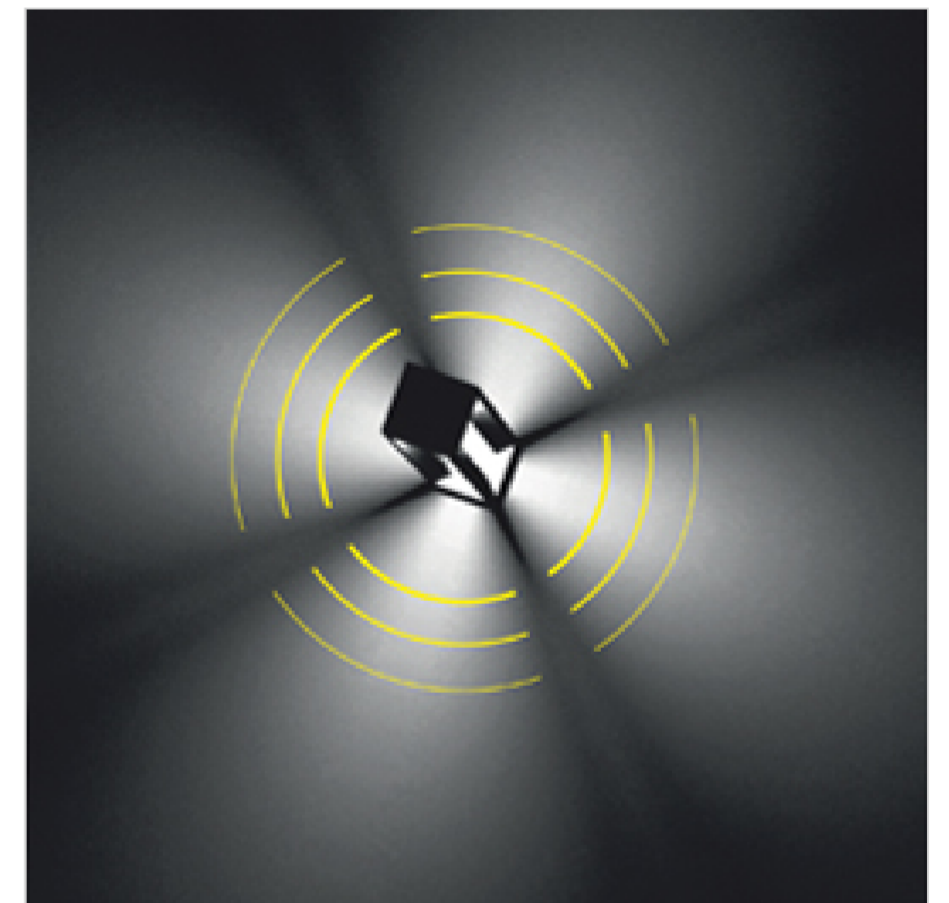
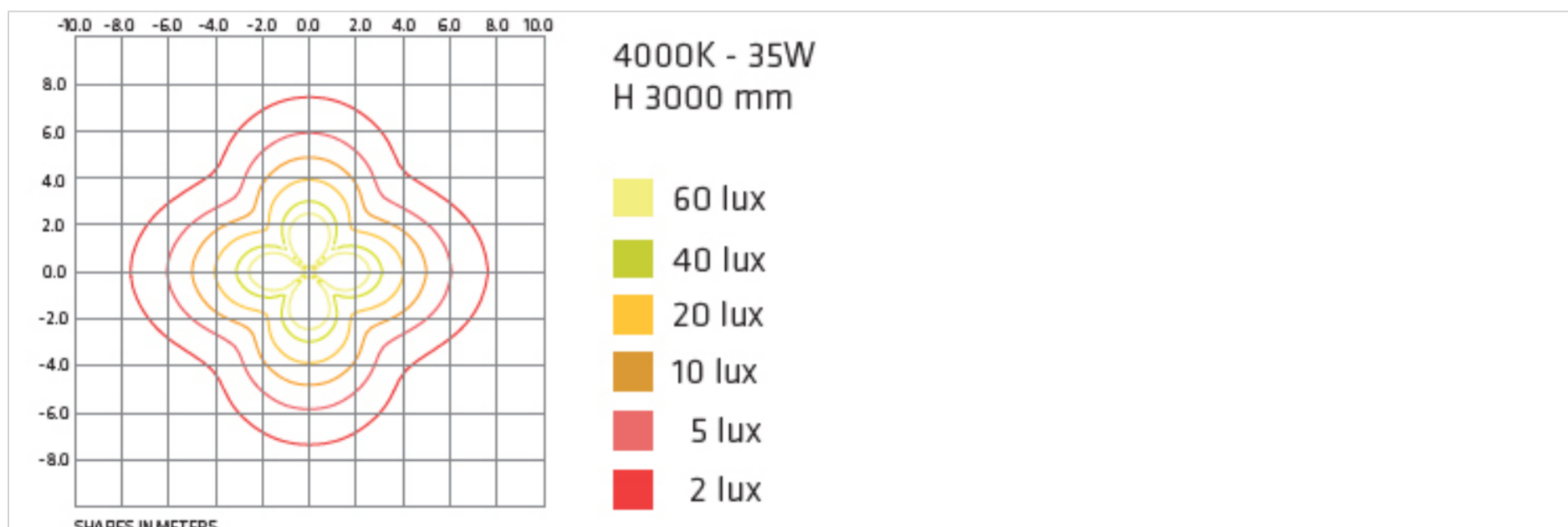

FIXTURE SPECIFICATIONS

ASSEMBLY / USAGE

Ground installation

PROTECTION

IP 65 - IK 08

BODY

Pole: Extruded aluminium alloy - Body/Base:
Die-cast aluminium alloy

SCREEN

Sandblasted Glass

SEALS

Closed-cell EPDM rubber

SCREWS

Stainless steel A2

PAINT / FINISHING

Anti-corrosive UV stabilised polyester powder

SIZES

H 3000 x L 340 x W 340

ELECTRICAL SPECIFICATIONS

POWER SUPPLY

220-240Vac 50/60Hz

DRIVER

Built-in

DRIVER CURRENT

900mA

DIMMER SYSTEM

DALI available on request

SPECIFIC WIRING

Inclusa/Included

POWER MODULE LED

32W

ABSORBED POWER

35W

SOURCE

LED

SOURCE FLUX

4720lm

FIXTURE SOURCE

2800 lm

APPARENT EFFICIENCY

59 %

INSULATION CLASS

I

OVERVOLTAGE PROTECTION

2kV-4kV

OPERATING TA

50 °

ENERGETIC CLASS

A

CCT LED

3000K

CRI

>80

STEP MACADAM

3

LIFE TIME TM-21

L80B10 50000h

PHOTOBIOLOGICAL RISK

RG1

OPTIK DISTRIBUTION

Silicone

BEAM OPENING

Downward/Diffuse

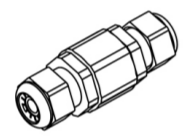
COLORS**ACCESSORIES**

MOR683P/2V Connector IP68 2Way/3Poles. Maximum section 3x2.5mm²
L82xØ28

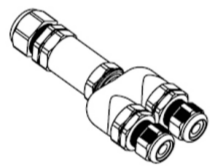

MOR685P/3V Connector Y, IP68 3Ways/5Poles. Maximum section 5x2.5mm²
L147xW73xH33



E.TRA.580 Ultra compact type 2+3 hard wired surge protector. CLI - IP67. Disconnection signaling by indicator. AC disconnection in case of end of life.
L37xW30xH30
L37xW30xH30

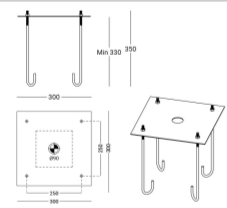

KIT.002 Ground anchoring system with anchor bolts and centring plate