

Orion D 560F2/WR35VS

Small Poles - Bollard 4 Ways H. 960

Rev. 31/10/2023



Column luminaire, for floor installation, with source light placed on top of fixture with a downward emission. This ensure an optimal light distribution on the ground and a better control of glaring effects. Floor fixing bracket with A2 steel clamps. Power supply with driver incorporated with fixed or dimmable output.

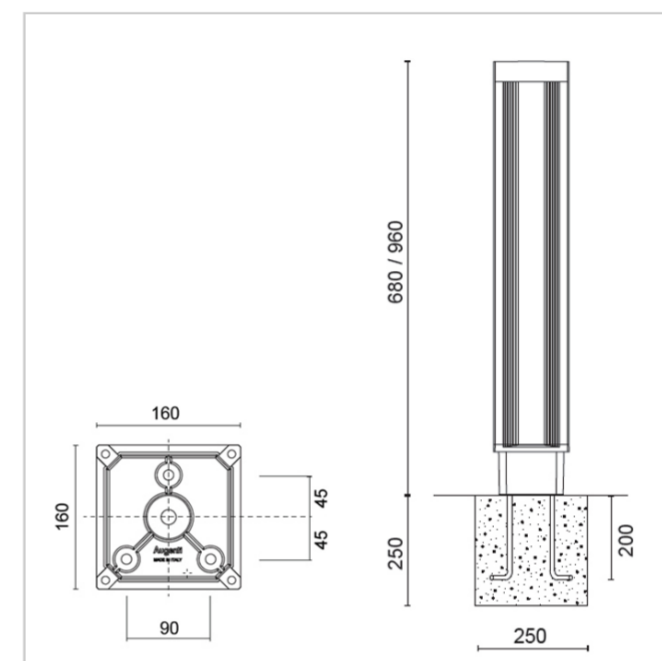
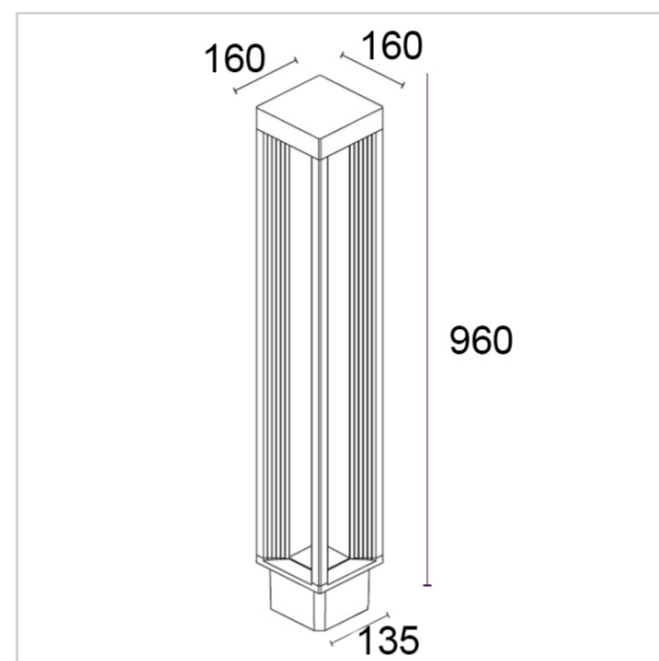

PHOTOMETRICAL DATA

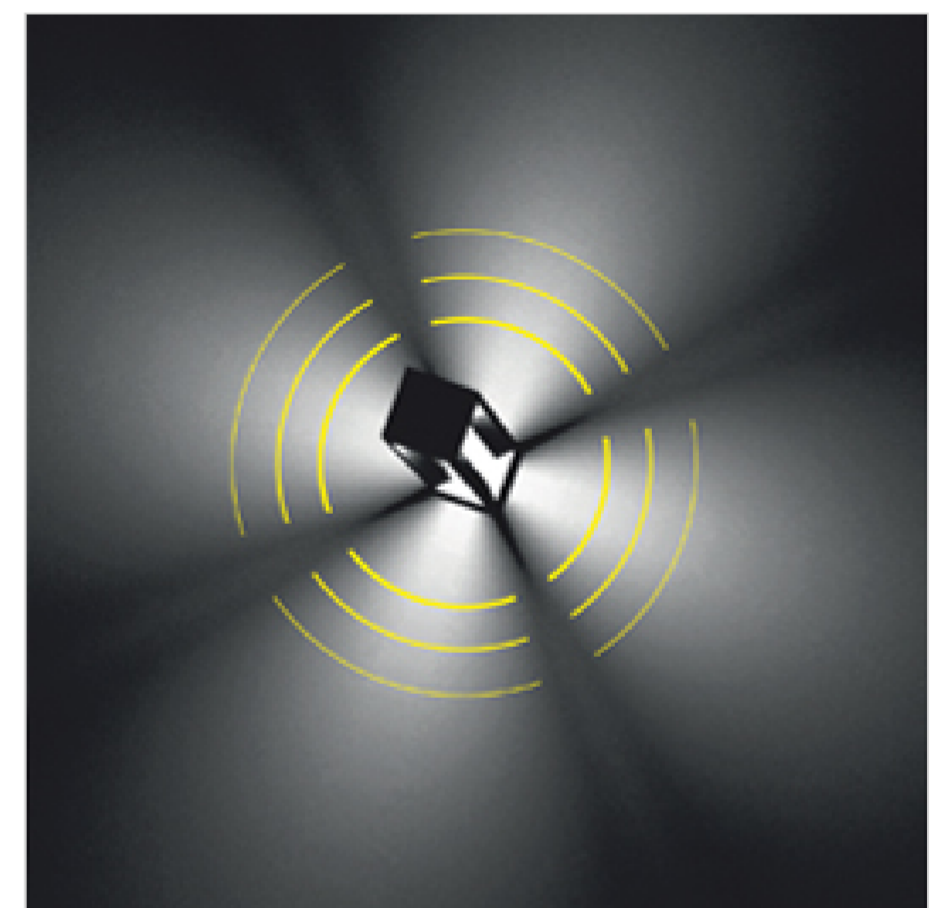
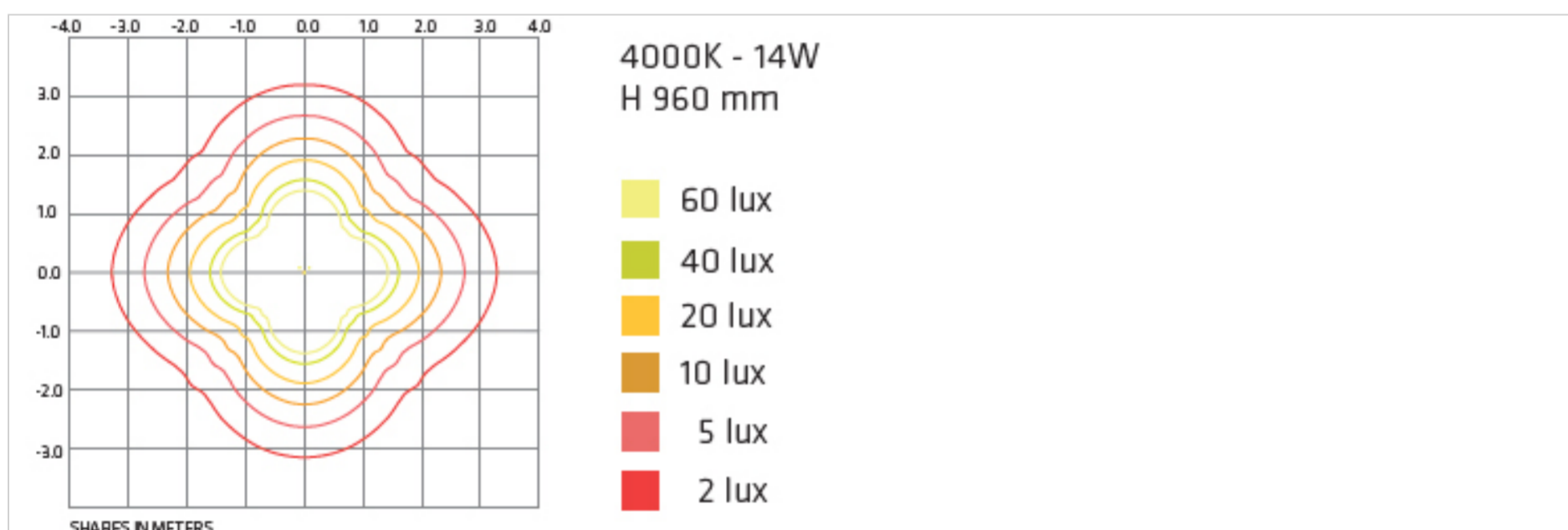

FIXTURE SPECIFICATIONS

ASSEMBLY / USAGE

Ground installation

PROTECTION

IP 65 - IK 08

BODY

Pole: Extruded aluminium alloy - Body/Base:
Die-cast aluminium alloy

SCREEN

Sandblasted Glass

SEALS

Closed-cell EPDM rubber

SCREWS

Stainless steel A2

PAINT / FINISHING

Anti-corrosive UV stabilised polyester powder

SIZES

H 960 x L 160 x W 160

ELECTRICAL SPECIFICATIONS

POWER SUPPLY

220-240Vac 50/60Hz

DRIVER

Built-in

DRIVER CURRENT

350mA

DIMMER SYSTEM

DALI available on request

SPECIFIC WIRING

Inclusa/Included

POWER MODULE LED

12W

ABSORBED POWER

14W

SOURCE

LED

SOURCE FLUX

1880lm

FIXTURE SOURCE

1120lm

APPARENT EFFICIENCY

60 %

INSULATION CLASS

I

OVERVOLTAGE PROTECTION

2kV-4kV

OPERATING TA

50 °

ENERGETIC CLASS

A

CCT LED

3000K

CRI

>80

STEP MACADAM

3

LIFE TIME TM-21

L80B10 50000h

PHOTOBIOLOGICAL RISK

RG1

BEAM OPENING

Downward/Diffuse >80

COLORS

00
PURE
WHITE RAL
9016

01
BLACK RAL
9005

10
WHITE RAL
9010

24
BRONZE

25
RUST

30
ANTHRACIT
E

35
SLATE
GREY

40
GREY RAL
9006

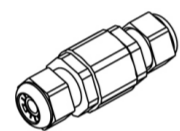
ACCESSORIES

MOR683P/2V Connector IP68 2Way/3Poles. Maximum section 3x2.5mm²
L82xØ28



E.TRA.580 Ultra compact type 2+3 hard wired surge protector. CLI - IP67. Disconnection signaling by indicator. AC disconnection in case of end of life.
L37xW30xH30
L37xW30xH30

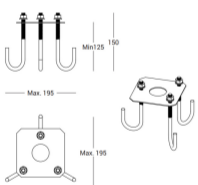

KIT.001 Ground anchoring system with anchor bolts and centring plate